

# 12FCX76

**8Ω****Coaxials** - 12.0 Inches

- 700 W continuous program power capacity
- 80° nominal coverage
- 47 - 18000 Hz response
- 98 dB sensitivity
- 50.5 mm (2") HF unit exit diameter
- Single Ferrite magnet assembly
- Aluminium demodulating ring allows a very low distortion figure

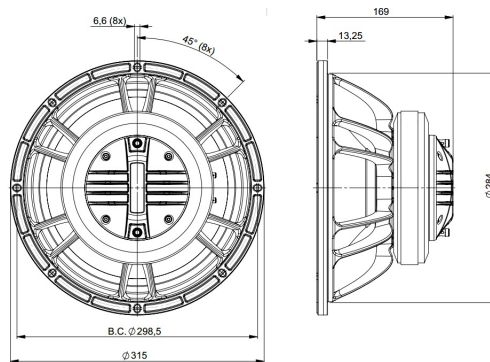

# 12FCX76

Coaxials- 12.0 Inches

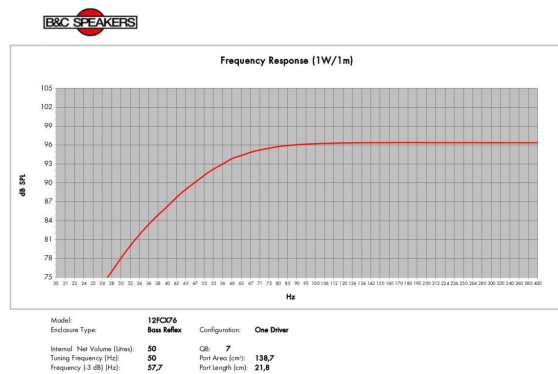
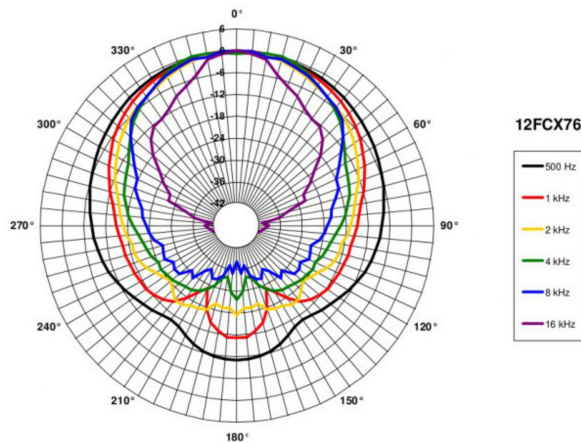
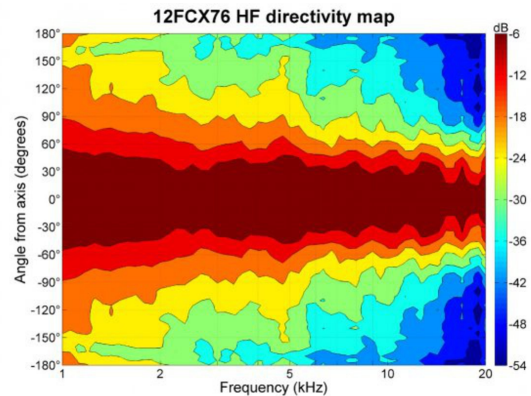
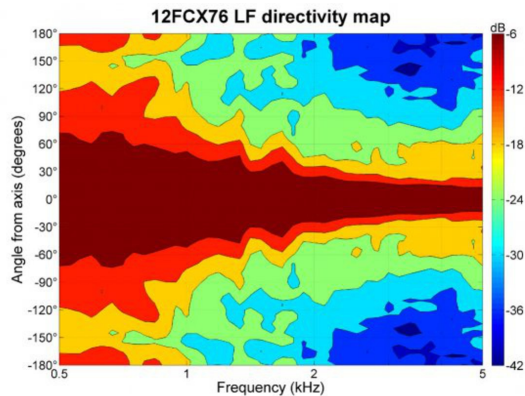
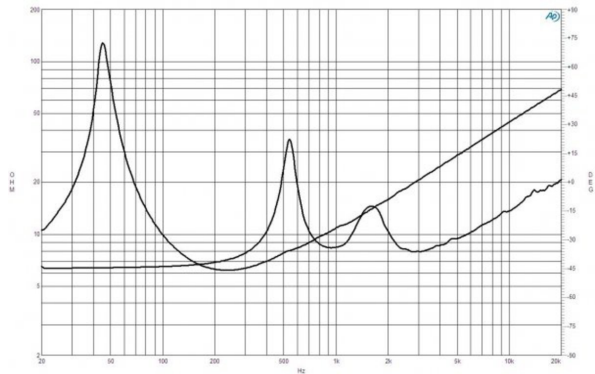
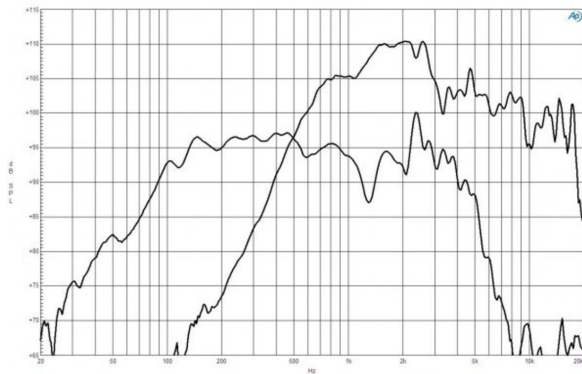

## SPECIFICATIONS

Nominal Diameter	320 mm (12.0 in)
Nominal Impedance	8 Ω
Minimum Impedance LF	6.3 Ω
Minimum Impedance HF	7.8 Ω
Frequency Range	47 - 18000 Hz
Dispersion Angle <sup>1</sup>	80 °
Woofer Cone Treatment	WP Waterproof Front Side
Magnet Material	Ferrite

## SPECIFICATIONS LF UNIT

Sensitivity <sup>2</sup>	98.0 dB
Nominal Power Handling <sup>3</sup>	350 W
Continuous Power Handling <sup>4</sup>	700 W
Voice Coil Diameter	76 mm (3.0 in)
Winding Material	Copper
Flux Density	1.0 T
Former Material	Glass Fibre
Winding Depth	16.5 mm (0.65 in)
Magnetic Gap Depth	8.0 mm (0.31 in)

## SPECIFICATIONS HF UNIT

Sensitivity <sup>5</sup>	106.0 dB
Nominal Power Handling <sup>6</sup>	80 W
Continuous Power Handling <sup>7</sup>	160 W
Voice Coil Diameter	75 mm (3.0 in)
Winding Material	Aluminium
Flux Density	1.6 T
Diaphragm Material	Titanium
Recommended Crossover <sup>8</sup>	1.2 kHz
Inductance	0.14 mH

B&C Speakers s.p.a.

Via Poggiomoro, 1 - Loc. Vallina, 50012 Bagno a Ripoli (FI) - ITALY - Tel. +39 055 65721 - Fax +39 055 6572312 - mail@bcspeakers.com

**PARAMETERS**

Resonance Frequency	47 Hz
Re	5.3 $\Omega$
Qes	0.35
Qms	11.0
Qts	0.34
Vas	82.0 dm <sup>3</sup> (2.98 ft <sup>3</sup> )
Sd	522.0 cm <sup>2</sup> (80.9 in <sup>2</sup> )
$\eta_e$	2.3 %
Xmax	$\pm$ 6.5 mm
Xvar	$\pm$ 5.0 mm
Mms	54.0 g
Bl	15.6 Txm
Le	1.3 mH
EBP	134 Hz

**MOUNTING AND SHIPPING INFO**

Overall Diameter	315 mm (12.5 in)
Bolt Circle Diameter	298 mm (11.7 in)
Baffle Cutout Diameter	282 mm (11.1 in)
Depth	169 mm (6.65 in)
Flange and Gasket Thickness	14 mm (0.55 in)
Net Weight	8.0 kg (17.6 lb)
Shipping Units	1
Shipping Weight	9.3 kg (20.5 lb)
Shipping Box	425x425x224 mm (16.73x16.73x8.82 in)

**CROSSOVER****SERVICE KIT**

LF recone kit	RCK12FCX768
MF replacement diaphragm	MMD3BTN8M

1. Included by -6 dB down points.
2. Applied RMS Voltage is set to 2.83V.
3. 2 hours test made with continuous pink noise signal within the range Fs-10Fs. Power calculated on rated minimum impedance. Loudspeaker in free air.
4. Power on Continuous Program is defined as 3 dB greater than the Nominal rating.
5. Applied RMS Voltage is set to 2.83V.
6. 2 hour test made with continuous pink noise signal within the range from the recommended crossover frequency to 20 kHz. Power calculated on rated minimum impedance. Loudspeaker in free air.
7. Power on Continuous Program is defined as 3 dB greater than the Nominal rating.
8. 12 dB/oct. or higher slope high-pass filter.